



The MKH Story

by Manfred Hibbing

Sennheiser’s professional MKH condenser microphones operate on the radio-frequency (RF) principle but they are certainly not wireless microphones. This special operating principle is not obvious from the outside but it clearly distinguishes the MKH microphones from other condenser microphones and is responsible for their exceptional properties.

High (RF) frequency solves a problem

When the replacement of electronic valves (vacuum tubes) by transistors commenced at the end of the 1950s, this change was also under consideration for condenser microphones. Reduced size, low supply voltages and low power consumption were regarded as great benefits, as well as being able to use simpler microphone cables. However, there was a basic problem: direct replacement of the valve by a transistor was not possible due to the mismatch between the high impedance of the condenser capsule and the low input impedance of the transistor. Hence, for optimal matching, the capsule impedance needed to be drastically reduced.

The impedance of a condenser capsule of 40 pF capacitance decreases with rising frequency from 200 MΩ at 20 Hz to 200 kΩ at 20 kHz. At high (radio) frequencies, for instance at 10 MHz, the impedance is reduced to 400 Ω which is a convenient value for driving transistor inputs. So microphone manufacturers started to develop various RF circuits; but as soon as field-effect transistors (FETs) with properties similar to valves were available, all manufacturers but one abandoned the RF technique. At that time Sennheiser had already solved the crucial problems associated with this technology and, as a then newcomer, Sennheiser was not bound to existing technical conceptions but could break new ground.

How does RF microphone technology work? The principle is simple: Sound waves deflect the diaphragm of the condenser capsule and change the capacitance between the diaphragm and the nearby back electrode (backplate). Contrary to the more common low frequency (AF condenser) method, the capacitance variations are not converted directly into audio signals but modulate a high-frequency (radio-frequency) signal generated by an oscillator inside the microphone. This signal is then immediately demodulated inside the microphone, thus recreating the audio signal but with a very low source impedance that is well-suited for driving a transistor amplifier. Thus an RF condenser microphone is basically comprised of a transmitter and receiver that are directly wired together. The RF signal is therefore kept inside the microphone; only the audio signal is supplied to its output, just like all other microphones.

Radio frequency can be modulated in different ways. Most obvious in this case is frequency modulation (FM). If the resonant circuit of an oscillator is formed by the capsule and a coil, then its frequency is varied directly by the capsule capacitance variations. For technological reasons Sennheiser preferred the related ‘phase modulation’ because the noise performance of the oscillator could be improved by using a quartz crystal.

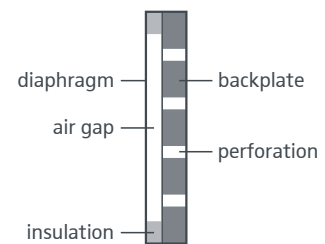

Sketch of a capacitive transducer
Diaphragm and backplate form a capacitor. Its capacitance is varied by the diaphragm excursion. The holes in the backplate provide the ‘breathing’ of the capsule.

Floating output and less interference due to AB powering

In 1962 Sennheiser launched the omnidirectional MKH 104 as the first RF condenser microphone, which was soon followed by the cardioid MKH 404. These microphones had unbalanced signal outputs. At about the same time 12 V AB powering ("Tonader" T-powering, sometimes called T12 powering) was introduced. It provided a balanced output and shared the two cable leads for both signal conduction and powering. Blocking capacitors prevented the DC from getting into the audio circuit. The screen was not used for the current flow. Now condenser microphones could use the same cables as dynamic microphones. The MKH microphones with AB-powering were given the model code '5' (MKH 105, MKH 405 etc.). Later a 'T' was added (MKH 105 T etc.) according to the new AB powering standard.



Sennheiser's first RF condenser microphone, the omnidirectional MKH 104

Although the capsule was connected to the microphone case and thus grounded, the electrical circuit was totally floating. The insulation was provided by separate windings of the RF coils. Thus AB powering in combination with the RF technique featured a transformerless balanced and floating output inherent in the design. From the beginning all MKH microphones were transformerless. This not only reduced the size of the electronics but also avoided signal distortion caused by transformers. Due to its interference-free performance, AB powering was recommended by the German Institut für Rundfunktechnik (IRT).

Extended bass and less noise with smaller capsules

The output impedance of the RF circuit is low and independent of the audio frequency. Therefore the inherent noise is low and nearly white, almost without flicker noise. These properties enable frequency response correction (equalising) without causing annoying noise. For instance the response of pressure-gradient microphones can be extended at low frequencies. Thus the bass response of small diaphragm capsules can be improved to an extent comparable with much larger capsules. But small capsules feature better directional characteristics at high frequencies as the onset of the pressure build-up effect is shifted towards higher frequencies.

Frequency response corrections are also feasible at high frequencies, thus acoustic resonators – as used in many AF condenser microphones – can be avoided. This improves the impulse response and prevents tonal colourations. The phase response is not affected by this means because linearisation of the frequency response also corrects the phase response. This is valid for both electrical and acoustical minimum phase networks. So MKH microphones not only have a flat frequency response, they also have a linear phase response.

Electrical linearization of the frequency response was utilised from the very start to improve the properties of the MKH microphones, and it was also beneficial for improving the noise characteristics. The theory was as follows: Each microphone capsule incorporates acoustic resistances for forming the frequency response and the directional characteristics. Equalising the frequency response by pure acoustical means requires quite large resistances that cause additional noise like electrical resistances. So, by reducing the acoustic resistances, the noise floor can also be reduced. This also improves the matching of the transducer to the sound field and increases its sensitivity. Furthermore, due to an appropriate acoustic design, the transducer sensitivity can be increased, especially between 2 kHz and 8 kHz where human hearing is most sensitive to noise. The higher capsule output also reduces the contribution of the amplifier noise. These effects support each other so that this 'low impedance design' improves the noise performance of the microphone considerably. The frequency response caused by this 'physiological' optimisation is no longer flat but can easily be corrected electronically. Due to this design, even the first MKH microphones had an extraordinary low inherent noise performance. An added bonus in this design is that it enables the designer to achieve a polar pattern closer to the theoretical with less off-axis anomalies. The directional performance can be designed nearly independently of the frequency response because the latter can be corrected electronically.

No problems with humidity

There is another important benefit of the RF principle for practical use. The low electrical impedance of the capsule provides outstanding immunity against detrimental effects due to humidity, because even then the leak resistance is very much larger than the capsule impedance. Thus MKH microphones are well-suited for outdoor use. In normal AF condensers the stored charge on the high-impedance capsule finds it easy to leak away across the insulation on water molecules, which can cause noise and 'crackling' effects. This is why outdoor recording became an important domain of the MKH microphones; especially as interference-tube microphones ('shotguns') with increased directivity and good suppression of ambient noise were available. The short shotguns MKH 415 and MKH 416 soon became the industry standard.



The MKH 415 short gun microphone

New MKH models for phantom powering

Besides AB powering, phantom powering was also introduced and became the standard microphone powering over the course of time. Nowadays nearly all microphone inputs provide this powering. With phantom powering the supply current is equally conducted via both signal leads of the microphone cable and returned via the cable screen. This powering does no harm to dynamic microphones, as the DC potential is the same at both microphone terminals; this prevents current flowing through the moving coil. So phantom powering need not be switched off when using dynamic microphones.

The MKH line was extended by microphones for 12V and 48V phantom powering (P12, P48), which received the model code '6' (MKH 106 P12, MKH 106 P48 etc.). Again, the RF operation facilitated a transformerless balanced and floating output. Associated with this development was a circuit redesign of the AB models, which then also received the model code '6' (MKH 106 T, etc.). In the mid 1970s for each method of powering there was an omnidirectional microphone (MKH 106), a cardioid (MKH 406), a short shotgun (MKH 416) and a long shotgun (MKH 816). Later the microphones' quartz crystal was replaced by an LC circuit which made them even more rugged.

After phantom powering had become the de-facto standard, the production of the AB microphones declined successively. Only the MKH 416 T survived because recording equipment that provides only this powering is still in use. At the end of the 1990s the shotguns MKH 416 T and MKH 416 P48 were completely redesigned without altering the essential acoustic properties of the microphones. The goal was, besides the implementation of new production technologies, the tightening of production tolerances.

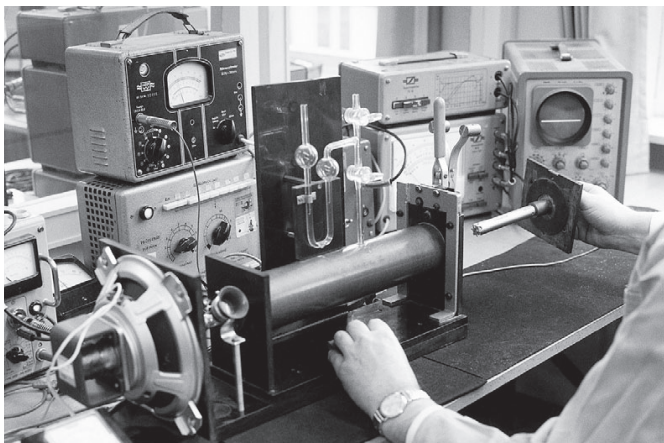

Measuring set-up for the MKH 110 low-frequency microphone

Microphones detect subsonic sound

As the RF technique operates down to 0 Hz without limitations, special microphones for subsonic measurement applications were developed. The subsonic microphones MKH 110 and MKH 110-1 featured lower limiting frequencies of 1 Hz and 0.1 Hz, respectively. Apart from this special application the frequency response of conventional transducers is limited at low frequencies by a pressure equalising port in order to suppress subsonic signals in normal recordings.

New non-linearity analysis

A new challenge for microphone development arose at the beginning of the 1980s when digital recording found its way into the studios, and the LP was, over time, replaced by the CD. Now the music connoisseur, for the first time, could hear the filigrees of sound in the same way that the recording engineer could. But now any imperfections in the microphones, which were formerly concealed by the noise and distortion of the tape and the vinyl record, were now detectable by anyone with decent equipment. At that time Sennheiser made investigations on the sources of the tonal differences between studio microphones for optimising a new line of studio microphones. Not only the frequency responses and directional characteristics of established studio microphones were reviewed but their non-linear distortions were also analysed.

At that time distortion measurements on microphones were regarded as problematic because sound sources with sufficiently low distortion were not available. Therefore the specified distortion exclusively concerned the microphone amplifier. Capsule distortion was not included. Sennheiser eliminated these difficulties by measuring the difference-frequency distortion instead of the more common harmonic distortion (THD). Two sounds of equal pressure (104 dB SPL) were applied simultaneously and separately via two loudspeakers to the microphone under test. The frequencies differed by 80 Hz. The distortion component generated by the microphone at the difference frequency 80 Hz (difference tone) was filtered out and measured. The distortion of the loudspeakers did not affect the test results because each loudspeaker produced only a single tone, and the harmonic distortions (THD) of the loudspeakers were far beyond the pass-band of the filter. The twin-tone signal was swept from 200 Hz to 20 kHz with an 80 Hz frequency offset. Contrary to THD measurements, the difference-frequency method enables measurements in the whole upper audio frequency range as the difference-frequency component is kept inside the audio frequency domain.

The measurement results revealed very individual distortion characteristics of the various microphones. The distortions were low at low frequencies but increased remarkably at higher frequencies. The onset frequency was lower for large capsules and higher for small ones. The distortion increases almost linearly with the sound pressure. As the sound pressure level of the test tones was more than 20 dB below the overload level of the microphones, at least ten times higher distortion can be expected near the overload limit.

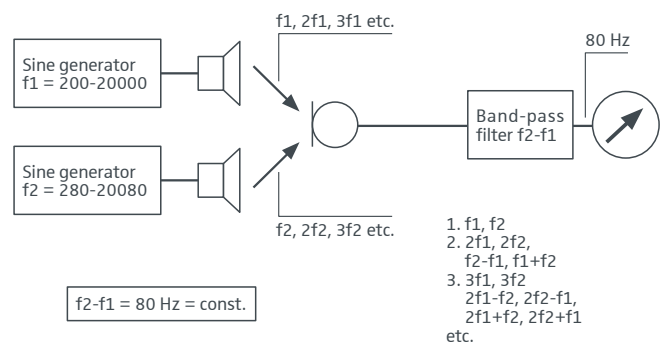

Difference frequency test set-up

The microphone under test is simultaneously exposed to two tones of 104 dB SPL via two loudspeakers. The distortion component at $f_2 - f_1$ is selected by a narrow band-filter and measured.

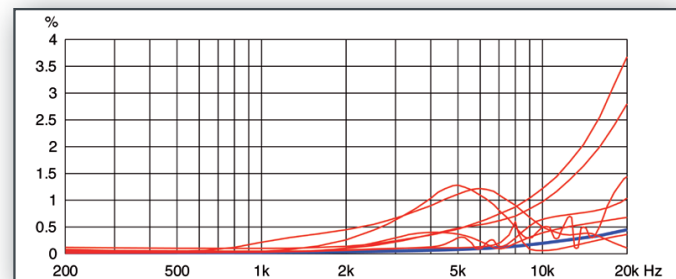

Difference frequency distortion of studio condenser microphones (cardioids)

The blue curve shows the improvement yielded by the push-pull capsule design of the MKH 40 compared with other top-quality studio condenser microphones

Push-pull pulls distortion down

Theoretical and practical investigations revealed that the source of the distortions is located in the narrow air gap between the diaphragm and the backplate of the condenser capsule. The viscosity of the air trapped inside this gap causes frictional forces that impede the diaphragm movement. With the diaphragm moving outwards the air motion is easier, due to the wider gap, than with an inwards motion. This difference causes a non-linear reacting force and thus distorts the diaphragm movement. Additional tonal components result, which affect the filigree of the sound. Besides harmonic distortion components (THD) that can enrich the overtone structure and are less conspicuous, annoying disharmonic components may appear due to intermodulation effects. If these components are low, they will not be perceived as distortions but rather like a lack of transparency or tonal resolution – like looking through a not perfectly clean window.

The distortion of microphones increases with signal level. This is also a general property of analogue equipment and sound storage mediums. Therefore microphone distortion was previously concealed by the deficiencies of the analogue recording technique. However, digital signal processing exhibits an opposite effect. The linear quantisation of digital signal conversion improves the linearity especially at high signal levels. Thus digital audio can reveal microphone distortions, especially at high sound pressure levels.

After the origin of the microphone distortion had been detected, the search for an efficient remedy began. In the end the symmetrical push-pull principle was selected, not only as the most effective, but also the most sophisticated method. The transducer was equipped with an additional plate in front of the diaphragm that was identical to the backplate. Thus two equal air gaps on both sides of the diaphragm were formed. Due to the symmetrical design, the reacting forces in both air gaps sum to an almost constant value if the diaphragm is moved in either direction. So the diaphragm movement is virtually distortion-free. This effect was supported by the acoustic transparency of both plates due to a high degree of perforation. Thus the balanced push-pull transducer was born as the heart of a new professional condenser microphone range.

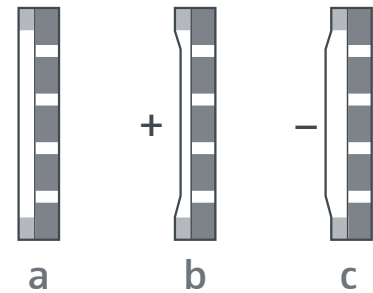

Capacitive transducer

- a Diaphragm at rest position
- b Positive pressure moves the diaphragm towards the backplate. The narrowed air-gap increases the frictional forces and impedes the air motion.
- c Negative pressure moves the diaphragm outwards. The wider air-gap eases the air motion due to reduced frictional forces.

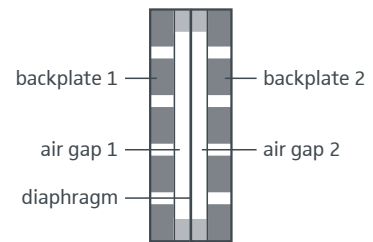

Balanced push-pull transducer

The diaphragm is centred between two equal backplates creating two equal air-gaps and two equal capacitors.

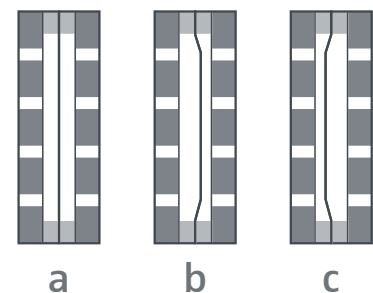

Distortion cancellation due to balanced push-pull design

- a Diaphragm at rest position
- b, c Diaphragm excursions in both directions cause equal but opposite alterations of the air gap widths. Thus the sum of the forces reacting on the diaphragm is kept constant.

A new microphone line is born

A new microphone line was designed at the beginning of the 1980s to feature identical technical data as far as the differences were not dictated by the specific directional characteristics. Importantly, the frequency response should be flat for all types. The microphones should be neutral, without adding or omitting sound details.

The RF circuitry was completely redesigned, now utilising amplitude modulation (AM) instead of phase modulation. This was evident, as the capsule is comprised of two capacitors with opposite varying capacitances. The capsule was combined with a centre-tapped coil to form an RF bridge. The capsule capacitances functioned like a capacitive potentiometer with the diaphragm as the wiper. This circuit exhibited an extraordinary linearity.

The cardioid MKH 40



The MKH 40, as the first microphone of the new symmetrical-capsule MKH line, was launched in 1985. This microphone actually incorporated all the essential specifications of the future microphones. The frequency response was virtually flat from 40 Hz to 20 kHz, and the directional characteristics were stable over a wide frequency range. The distortion was extremely low, and the equivalent noise level of 20 dB(CCIR) and 12 dB(A), respectively,

set a new milestone. The high sensitivity of 25 mV/Pa provided an interference-free operation even with long cables and reduced the noise contribution of the microphone amplifier considerably. Switches for pre-attenuation and bass roll-off were also incorporated, with the bass roll-off switch compensating for the proximity effect.

The positive response of the sound engineers was encouraging. This indicated that the technical efforts had not only improved the measured results, but also yielded audible improvements in normal recording situations.

The omnidirectional MKH 20



The next microphone requested by many sound engineers was an omnidirectional one. This type of microphone was rediscovered at the onset of digital audio because it enabled the engineer to include more authentic room acoustics than other microphone types. The MKH 20 (launched in 1986) met these expectations as its low noise performance revealed even faint tonal structures.

With omnidirectional microphones, usually a decision has to be made between versions optimised for free-field or diffuse-field applications. The MKH 20 is switchable to both characteristics and, in addition, is supplied complete with a removable pressure ring enabling fine-tuning of the treble balance.

The bidirectional MKH 30 (figure-of-eight)



The omnidirectional microphone as a pure pressure transducer represents one end of the directivity scale. The other end is occupied by the bidirectional characteristic of a pure pressure-gradient microphone. Therefore the development of a bidirectional microphone seemed reasonable. Moreover, the push-pull transducer was predestined for this application due to its symmetrical design.

At that time the frequency responses of many bidirectional microphones showed deficiencies at low and high frequencies. Contrary to these microphones the MKH 30 (launched in 1987) was designed as a full studio microphone with a flat and extended frequency response. Therefore the MKH 30 is also very suitable as a spot microphone, which facilitates a high degree of acoustic separation between adjacent sound sources. Due to its frequency independent directional characteristics and tonal neutrality it allows a higher degree of reinforcement than other microphone types. In addition, as both front and rear lobes are identical, the MKH 30 is the ideal side microphone in an MS recording rig.

The super-cardioid MKH 50



A super-cardioid was the next microphone type in the schedule. Compared to cardioids, super-cardioids usually exhibit less bass response. The MKH 50 (launched in 1988) breaks with this tradition as it features the same extended bass response as the MKH 40. The directional properties at high frequencies are also well-balanced. The reason for this is the affinity of the super-cardioid pattern to the directional characteristics due to the pressure build-up effect. All microphones are prone to this effect at high

frequencies, nearly independent of the rated directivity at lower frequencies. Pressure build-up occurs if the sound waves at high frequencies are no longer bent around, but are more or less reflected by, the microphone, which then acts as an acoustic obstacle. On-axis sound can cause a pressure boost of up to 10 dB. This changes the pressure profile at the transducer so that the directional properties are dominated by the pressure build-up effect. The sophisticated acoustic design of the MKH 50 provides a smooth crossover from the super-cardioid to the pressure build-up characteristic.

The interference tube (shotgun) microphones MKH 60 and MKH 70



The next microphones were designed to accompany the interference tube (shotgun) microphones MKH 416 and MKH 816. The new shotguns MKH 60 (short) and MKH 70 (long) (both launched in 1991) were not intended to replace the older types, but rather for extending the shotgun line. So the MKH 60 was designed slightly longer than the MKH 416, and the MKH 70 a little shorter than the MKH 816. The MKH 816 was too long and too heavy in many cases, so most users preferred the MKH 70. The MKH 60 became a companion of the MKH 416 and was used if more directivity was required. It can also be used as a spot microphone for high-grade music recording at longer microphone distances. The weight of the new shotgun microphones was minimised without compromising the mechanical stability. Both microphones featured switches for pre-attenuation, bass roll-off and treble boost.

The multi-pattern microphone MKH 800



The MKH 80 was launched in 1993 as the first MKH with switchable patterns (omnidirectional, wide cardioid, cardioid, super-cardioid and figure-of-eight). It was replaced in 2000 by the MKH 800 as the first MKH with an extended frequency response of up to more than 50 kHz. Both microphones incorporate a twin capsule with two symmetrical push-pull transducers. A new design avoided the disadvantages of common dual-diaphragm transducers. It is well-known that the cardioid or super-cardioid patterns of these transducers get wider at low frequencies and thus may cause undesirable bass emphasis in reverberant environments. The MKH twin capsule incorporates additional acoustic inputs that stabilise the directional characteristics at low frequencies. So the field of applications is remarkably extended. As ambient sound is recorded neutrally these microphones are also well-suited as spot microphones, allowing a high degree of reinforcement without introducing degrading sound colourations.

The extended high-frequency response of the MKH 800 is Sennheiser's contribution to the improvements of digital recording technology due to higher sampling rates that extend the audio frequency range by at least one octave at high frequencies. In order to benefit from this improvement, an adequate extension of the microphone response is desirable. Previous investigations had revealed that the sound emission of musical instruments continues above 20 kHz with a steeper roll-off beyond 50 kHz. Thus the frequency response of the MKH 800 was extended to more than 50 kHz.

The twin-capsule of the MKH 80, due to its acoustic properties, was well suited for this extension and did not require any changes to the basic design. So the extension of the frequency response only needed some changes to the electronic equalisation circuit. The resulting extraordinarily fast impulse response also set a new milestone for improved tonal resolution.

Though it is still debatable whether frequencies above 20 kHz are exploitable by human hearing, this extended frequency range should not really be filtered out. With the MKH 800 and high sample frequency recording, the sound engineer can be sure he is on the safe side.

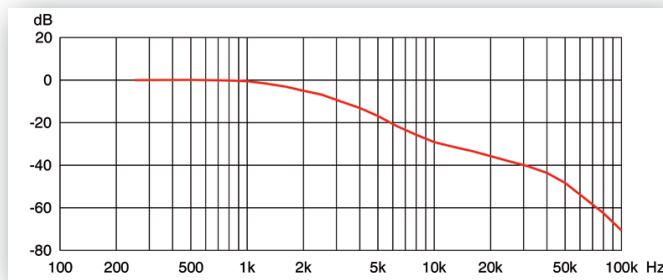

Third-octave spectrum of a symphonic orchestra
The sound emission continues until 40 kHz with only a slight decrease; a steeper roll-off only occurs above 50 kHz.

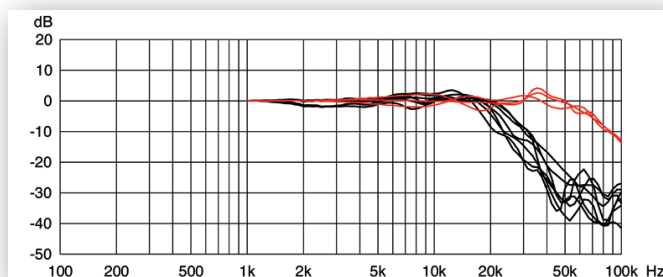

Frequency response of the MKH 800 (red) compared to other studio microphones.
The sensitivity of the MKH 800 is up to 20 dB higher beyond 20 kHz.

The versatile MKH 800 TWIN



It is a well-known experience of sound engineers that microphone polar patterns may turn out during or after recording to be sub-optimal, but changes are then no longer possible. The MKH 800 TWIN, (launched in 2008) offers a smart solution to this problem. The TWIN microphone is technically based on the MKH 800 and comprises the same twin-transducer with its front and back cardioid polar-patterns. However, both transducer signals are not combined inside the microphone to create a specific directional pattern but are available separately at the microphone output. The signals are remotely mixed under monitoring conditions by faders at the console. This is done as follows:

Route the signals of the front and back cardioids to adjacent faders. Then set the recording level by the fader of the front cardioid. Preserve this fader position for the following (it is assumed, for simplicity, that the fader position is 0 dB and that equal pre-gain is set for both signals):

If the back cardioid fader is closed, then only the front cardioid pattern is activated. If the fader is set to -10 dB then the wide cardioid (sub-cardioid / hypo-cardioid) results, as 30% from the back cardioid is added to the front cardioid. At the 0 dB position both cardioids add to make the omnidirectional pattern.

If the polarity of the back cardioid is inverted then at 0 dB fader position the figure-of-eight pattern results by subtraction, and accordingly the super-cardioid is formed at the -10 dB position by subtracting 30% of the rear cardioid.

As the rate of the rear cardioid can be altered continuously by the fader position, the directivity can subtly be controlled from omnidirectional to cardioid, and with inverted polarity from cardioid to figure-of-eight. The directivity pattern can smoothly be optimised by monitoring without noise and delay, even during a live performance.

The relative position of the rear cardioid fader always defines the back (180°) rejection of the resulting pattern, which for instance is 10 dB for both wide cardioid and super-cardioid. Evidently, the polarity inversion of the rear cardioid inverts also the polarity of the rear lobes of the resulting super-cardioid or figure-of-eight characteristics.

Some digital microphones also enable remote control of the directional pattern, but again both signals are combined inside the microphone, and thus signal information is irretrievably lost. In contrast, the MKH 800 TWIN maintains the total information in two channels. If both signals are stored this information is also available for future applications. This opens a new dimension of recording practice as it provides maximum flexibility during post-production, and eliminates the need for determining the microphone patterns before the recording session.

Stereo and surround sound productions can be mixed in parallel with differing directional patterns. Thus the sound engineer is no longer forced to favour one or the other before recording. Due to the symmetry of the TWIN, additional backward-oriented patterns can be generated, for instance for surround sound productions. MS and double MS configurations with a laterally oriented bidirectional microphone (e.g. MKH 30) enable additional set-ups. Optionally a centre channel can be generated with an arbitrary directional pattern. In all cases only three microphone signals have to be stored for post-production.

Thus the creativity of the sound engineer is virtually unlimited. Moreover, the small size of the MKH 800 TWIN enables optically unobtrusive applications. Obviously this microphone is the most versatile member of the MKH line.

The new MKH 8000 line



The long MKH 8070 rifle microphone was designed for picking up distant sound sources. It was launched in 2011, together with the MKH 8060 short gun microphone.



The MKH 8090 wide cardioid condenser (launched in 2012)

There were many reasons for the development of the new MKH 8000 line, which was launched in 2007 with the MKH 8020 (omni), MKH 8040 (cardioid) and MKH 8050 (super-cardioid) and has been continuously expanded since then. Most important was an unobtrusive design for video productions etc. Furthermore a modular concept was planned for more versatile applications. From the start, it was decided that the technical specifications of the MKH line should be maintained or, ideally, improved. This was a challenging task as the properties of the established MKH line still set standards even after more than twenty years in production.

Diameter and length of the new microphones were considerably reduced, as small-sized electrical components (SMD) were now available. Also new production technologies were applied. The push-pull transducer was redesigned in order to reduce its outer

size without changing the active diaphragm area. Actually, the active diaphragm of the new 19mm diameter MKH 8000 series has exactly the same diameter as the 25mm MKH 20-800 series: 16mm. Thus the excellent noise performance was maintained. The frequency response was generally extended to 50 kHz. This demanded a fine-tuning of the capsule design. The circuit design was taken from the MKH 800.

Modularity was a novel aspect of the new MKH line. The modular separation was not, as usually arranged, between the transducer and the electronics but behind the complete microphone unit. This concept combined the functionally associated parts to one unit and thus virtually eliminated external interference problems.

The microphone module can be combined with different modules, cables, stands etc., which are provided by an extensive range of accessories. A new feature is the creation of a digital microphone by combining the microphone module with the AES42 converter module MZD 8000. This digital module provides two channels, which can handle two microphones simultaneously, or a stereo or a twin microphone (e.g. MKH 800 TWIN) with special cables. If only one microphone is connected then both channels are driven in parallel and the S/N ratio is increased by 3 dB. Uniquely, this arrangement allows a stereo pair of MKH 8000 series microphones, with a Y-cable, to be connected to a single MZD 8000 and a simple connection kit to go into a standard AES3 digital input without requiring the recorder or mixer to be AES42 enabled.

Last but not least ...

The new microphones are based on a half-century of experience. All current MKH microphones have proved their high tonal authority and their reliability even in critical recording situations. The RF principle, which at the beginning assisted the changeover from valve technology to transistor technology, has improved to be an important base of modern microphone design.